

Datasheet Actuation Module: *Curve*® unplugged 3920E24



- Active length: **39 mm**
- Module size: **59 mm x 20 mm x 3.3 mm**
- Bending: **low (E24)**
- Module weight: **4.3 g**

Hosting structure and actuation module

- Example hosting structure: stainless steel 0.55 mm
- Load range with high cycling stability (> 300.000)

at module edge:	820 g
at 25 mm:	540 g
at 50 mm:	400 g

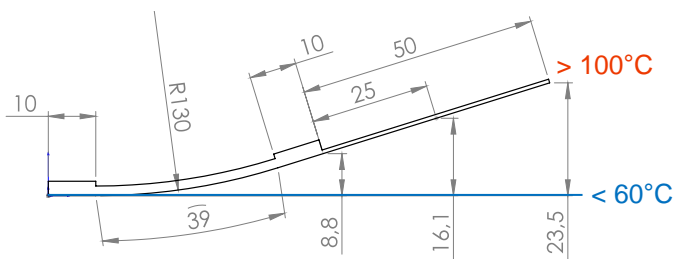

Actuation module

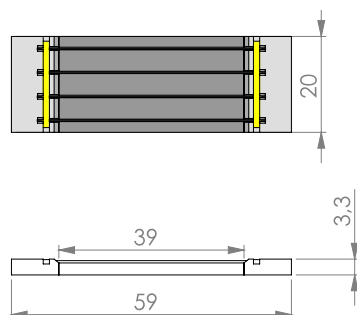

- Operating mode: **unplugged**
- Thermal activation by: external heating
- Possible external heating: convection, radiation, conduction
- Maximum temperature: 130°C permanent
>150°C short-term

© CompActive GmbH

All values are only estimations!

Customized high performance actuation modules by ...



... high-tech solutions

- reliable load transfer
- proven cycle stability
- injection molded frame elements
- special SMA material specifications
- high temperature FRP
- self-sensing capability

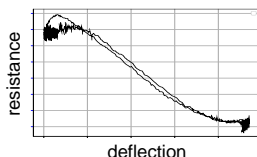
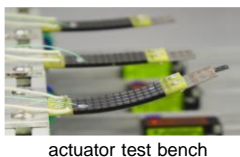

... individual design

- substrate (metals, polymers)
- size
- deflection
- load / cycles
- wire material / temperatures
- electrical resistance

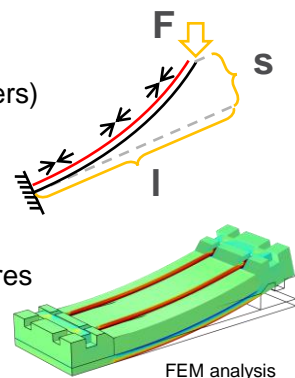

... customized mechanical fixation

- adhesive films
- liquid adhesives
- bolts, rivets, screws
- plug-on

... various electrical connection

- crimping
- soldering
- plugging in
- welding



© CompActive GmbH