

Datasheet Actuation Module: *Curve*® plugged 3930E24

- Active length: **39 mm**
- Module size: **59 mm x 30 mm x 3.3 mm**
- Bending: **low (E24)**
- Module weight: **6.4 g**

- Example hosting structure: stainless steel 0.55 mm
- Load range with high cycling stability (> 300.000)

at module edge:	2070 g
at 25 mm:	1110 g
at 50 mm:	760 g

- Operating mode: **plugged**
- Thermal activation by: resistive heating
- Electronic circuit: all wires in series
- Resistivity: 1.2 Ohm
- Full Activation (DC): e.g. 3 A for 15 s / 4 A for 4 / 5 A for 1.3 s

Hosting structure and actuation module

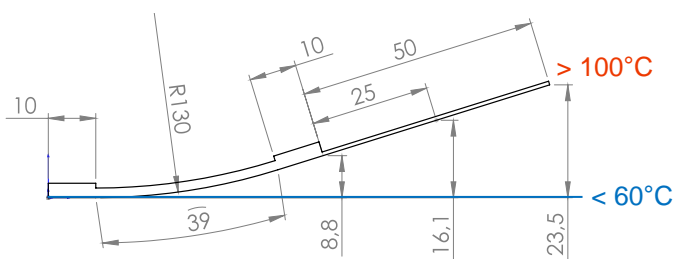

Actuation module

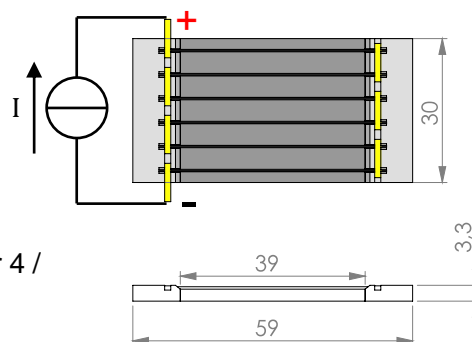

© CompActive GmbH

All values are only estimations!

Customized high performance actuation modules by ...

... high-tech solutions

- reliable load transfer
- proven cycle stability
- injection molded frame elements
- special SMA material specifications
- high temperature FRP
- self-sensing capability

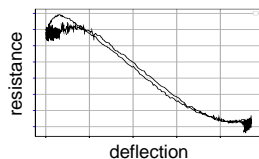

... individual design

- substrate (metals, polymers)
- size
- deflection
- load / cycles
- wire material / temperatures
- electrical resistance

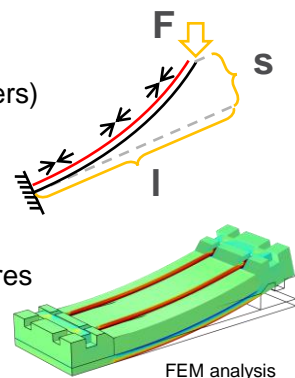

... customized mechanical fixation

- adhesive films
- liquid adhesives
- bolts, rivets, screws
- plug-on

... various electrical connection

- crimping
- soldering
- plugging in
- welding



© CompActive GmbH