

Datasheet Actuator: *Curve*® unplugged A2920E10

- Active length: **29 mm**
- Module size: 49 mm x 20 mm x 1.8 mm
- Bending: high (E10)
- Weight: 2.0 g + hosting structure
- Hosting structure: steel + rivets, **tip 25 mm**
size 84 x 20 x 0.35 mm³
- Load range with high cycling stability (> 300.000)
 - at module edge: 410 g
 - at 25 mm: 250 g**
 - at 50 mm: 180 g

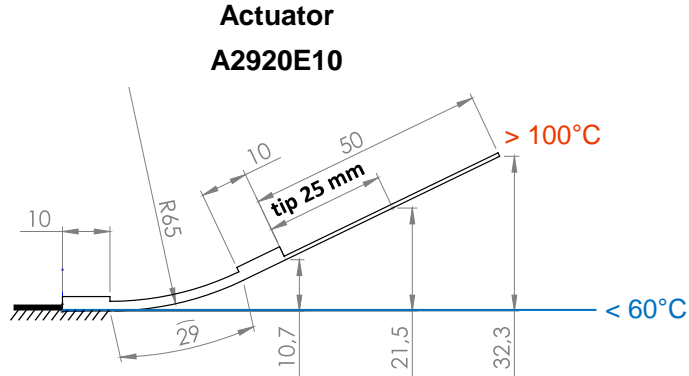

M2920E10 – Actuator Module only

- Operating mode: **unplugged**
- Thermal activation by: external heating
- Possible external heating: convection, radiation, conduction
- Maximum temperature: 130°C (permanent)
>150°C (short-term)

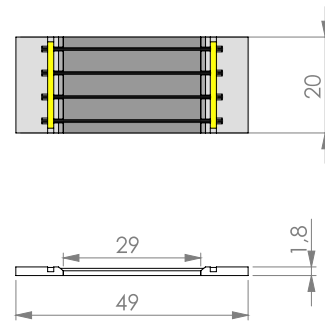

© CompActive GmbH

All values are only estimations!

Customized, high-performance actuators by ...

... high-tech solutions

- reliable load transfer
- proven cycle stability
- injection molded frame elements
- special SMA material specifications
- high temperature FRP
- self-sensing capability

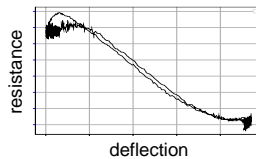

... individual design

- substrate (metals, polymers)
- size
- deflection
- load / cycles
- wire material / temperatures
- electrical resistance

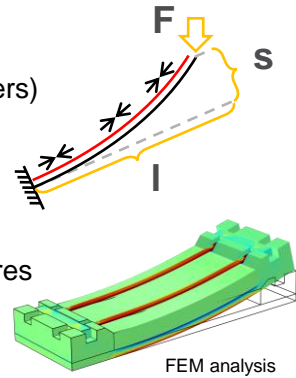

... customized mechanical fixation

- adhesive films
- liquid adhesives
- bolts, rivets, screws
- plug-on

... various electrical connection

- crimping
- soldering
- plugging in
- welding



© CompActive GmbH