

Datasheet Actuator: *Curve*® plugged A2920E24

- Active length: **29 mm**
- Module size: 49 mm x 20 mm x 3.3 mm
- Bending: low (**E24**)
- Weight: 4.0 g + hosting structure
- Hosting structure: steel + rivets, **tip 25 mm**
size 84 x 20 x 0.50 mm³
- Load range with high cycling stability (> 300.000)
 - at module edge: 1030 g
 - at 25 mm: 620 g**
 - at 50 mm: 450 g

- Operating mode: **plugged**
- Thermal activation by: resistive heating
- Electronic circuit: all wires in series
- Resistivity: 0.6 Ohm
- Full Activation (DC): e.g. 3 A for 15 s / 4 A for 4 s /
5 A for 1.3 s

Actuator A2920E24

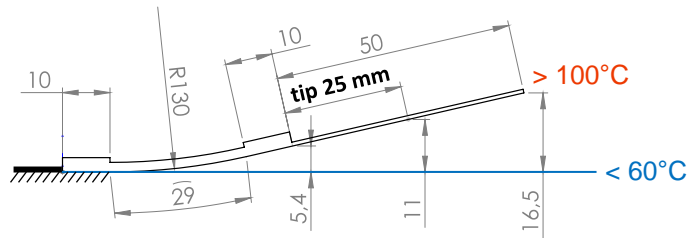

M2920E24 – Actuator Module only

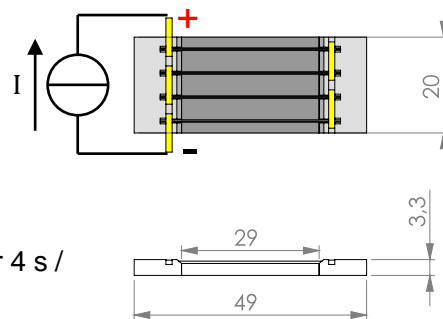

© CompActive GmbH

All values are only estimations!

Customized, high-performance actuators by ...

... high-tech solutions

- reliable load transfer
- proven cycle stability
- injection molded frame elements
- special SMA material specifications
- high temperature FRP
- self-sensing capability

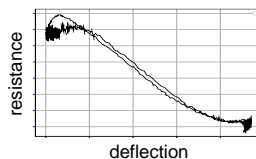

... individual design

- substrate (metals, polymers)
- size
- deflection
- load / cycles
- wire material / temperatures
- electrical resistance

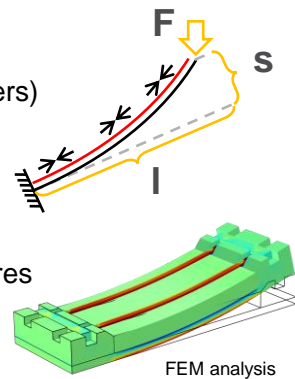

... customized mechanical fixation

- adhesive films
- liquid adhesives
- bolts, rivets, screws
- plug-on

... various electrical connection

- crimping
- soldering
- plugging in
- welding



© CompActive GmbH